

A Novel Reaction-Diffusion System based on Minority-Carrier Transport in Solid-State CMOS Devices

Tetsuya ASAI, Yuusaku NISHIMIYA, and Yoshihito AMEMIYA

Department of Electrical Engineering, Hokkaido University,
Kita 13, Nishi 8, Kita-ku, Sapporo, 060-8628, Japan.

Phone : +81-11-706-6080, Fax : +81-11-706-7890, E-mail : asai@sapiens-ei.eng.hokudai.ac.jp

I. INTRODUCTION

The reaction-diffusion (RD) system is a lively, dynamic system in which the reaction and diffusion of chemical species coexist under a nonequilibrium condition[1]. For instance, the Belousov-Zhabotinsky (BZ) reaction, which is a periodic oxidation-reduction phenomenon among liquid-state reagents, produces a variety of the rhythms and orders in the form of propagating chemical waves[2]. It gives us important cues to reveal the relation between chemical reaction and vital phenomenon in nature.

The RD phenomenon is usually observed in liquid- or gas-state medium. Our interest is to construct artificial RD system in *solid-state medium*, and to develop practical applications based on the vital phenomena. In this report, we propose one such device: namely, a solid-state RD system that imitates chemical RD systems.

To imitate the chemical system in solid-state devices, we propose an idea to use the minority carriers in the semiconductors as diffusion substances. Consequently, we regard the minority-carriers as chemical substances in the RD system. The diffusion of chemical substances in the RD system is then imitated by that of the minority-carriers in semiconductors. The chemical reaction, which results in the change of the concentration of the substances, is imitated by a *reaction device*. The reaction device regulates the concentration of minority-carriers according to the nonlinear chemical reaction. We first introduce a novel reaction device that imitates a substrate-depleted reaction. Then, we show dynamic behaviors of the solid-state RD system with the reaction circuits.

II. THE REACTION-DIFFUSION DEVICE

The proposed RD device consists of a number of reaction devices regularly arranged on a common silicon substrate, as shown in Fig. 1. Minority carriers produced by a reaction device will travel through the substrate by diffusion and reach the adjacent reaction devices to activate them.

The reaction device we propose is illustrated in Fig. 2. The device is constructed by four regions; i.e., $p+$, n -well, p -sub, and $n+$ regions. Figure 3 shows the cross-sectional view of the device along with a dashed line A in Fig. 2. A lateral p - n - p - n diode is formed beneath the substrate surface. The diode is connected with a capacitor and a p MOS FET acting as a current source. Figure 4 shows its equivalent circuit.

The reaction device exhibits excitatory (monostable) behavior if the supply voltage V_{DD} is lower than breakover voltage V_b of the p - n - p - n diode. Namely, the capacitor voltage v cannot reach V_b because v does not exceed supply voltage V_{DD} (bias current becomes 0 when v increases up to V_{DD}). The p - n - p - n diode turns on only when minority carriers are injected out of the device.

The state of the reaction device can be represented by two variables, i.e., the capacitor voltage (the charge stored on the capacitor) and the concentration of minority-carriers (electrons) in the p -sub region of the p - n - p - n diode. We modeled the dynamics of the reaction device as

$$C \frac{dv}{dt} = I_0 i(v) - \frac{v}{r(v, n)}, \quad q \frac{dn}{dt} = -q \frac{n}{\tau} + \frac{v}{r(v, n)}, \quad (1)$$

where C represents the capacitance, v the capacitor voltage, n the minority carrier concentration, $I_0 i(v)$ the current of the p MOS FET, q the charge of electron and τ the minority carrier lifetime. The characteristic of the p - n - p - n diode is represented by nonlinear resistance $r(v, n)$. The minority carrier concentration n increases through a multiplication process caused by the feedback mechanism of the p - n - p - n diode, while capacitor charge decreases by the amount equal to the increased minority carriers. Since the charge of the capacitor is depleted by the p - n - p - n device, this device imitates a substrate-depleted reaction.

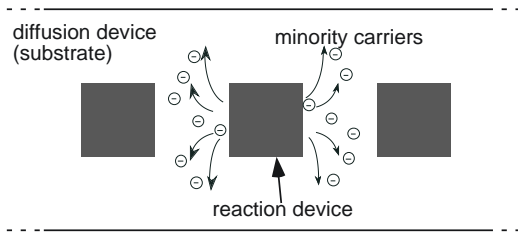

Fig. 1 Schematic image of the RD device

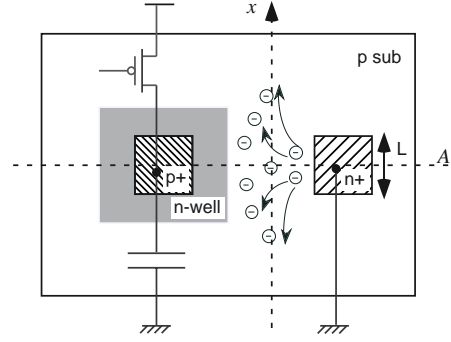

Fig. 2 The proposed reaction device (top view)

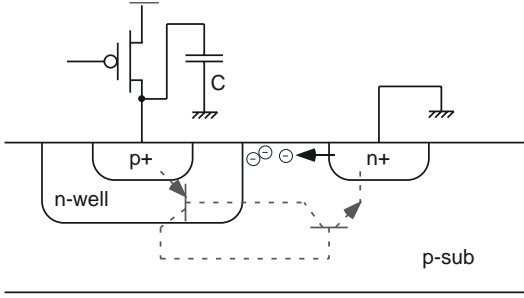

Fig. 3 The reaction device (cross-sectional view)

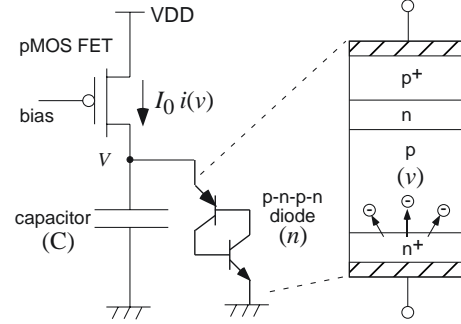

Fig. 4 Equivalent circuit of the reaction device

We designed one-dimensional RD device by arranging the reaction devices on a silicon substrate, as shown in Fig. 5. Minority-carriers (electrons) produced by a reaction device will travel through the p -sub region by diffusion and reach adjacent devices. When the reaction devices are closely arranged on the substrate, these minority carriers induce a chain reaction among the reaction devices. We estimate the minimum distance between adjacent devices to cause the chain reaction.

The minority carrier concentration along with the x -axis in Fig. 2 is given by

$$\frac{\partial n(x, t)}{\partial t} = D_n \frac{\partial^2 n}{\partial x^2} - \frac{n}{\tau}, \quad (2)$$

where D_n is the diffusion coefficient ($=\mu_n kT/q$). The impulse response to Eq. (2) is obtained as

$$g(x) = \frac{1}{\sqrt{4\pi D_n t}} \exp\left(-\frac{x^2}{4D_n t} - \frac{t}{\tau}\right). \quad (3)$$

When a reaction device turns on at $t = 0$, the minority carrier concentrates around the reaction device (Fig. 6). The total amount of the minority carriers in the p - n - p - n diode is assumed to be equal to the charge of the capacitor at $t = 0$. The minority carrier distribution $n(x, t)$ is thus obtained as

$$n(x, t) = n(x, 0) * g(x) = \frac{N_0}{2} \exp\left(-\frac{t}{\tau}\right) \left[\operatorname{erf}\left(\frac{x + L/2}{\sqrt{4D_n t}}\right) - \operatorname{erf}\left(\frac{x - L/2}{\sqrt{4D_n t}}\right) \right], \quad (4)$$

where L and N_0 represent the length of the reaction device (See Fig. 2) and the total amount of the charge of the capacitor ($= C VDD / q$), respectively.

Let us assume that the reaction device turns on when the total amount of the minority carriers in the p - n - p - n diode exceeds the amount of αN_0 (See Fig. 6). Then, minority carriers produced by a reaction device (R1 in Fig. 6) can turn on its adjacent device (R2 in Fig. 6) when

$$\int_{D+L/2}^{\infty} n(x, t) \geq \alpha N_0 \quad (5)$$

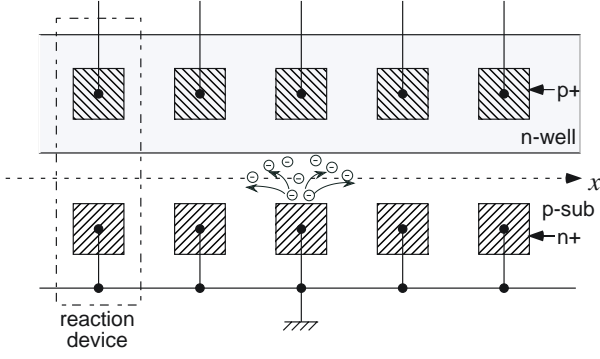

Fig. 5 The RD device consisting of 1-D array of reaction devices

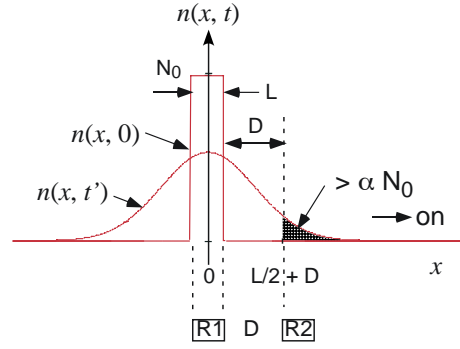

Fig. 6 Turn on condition of R2 through R1 and D

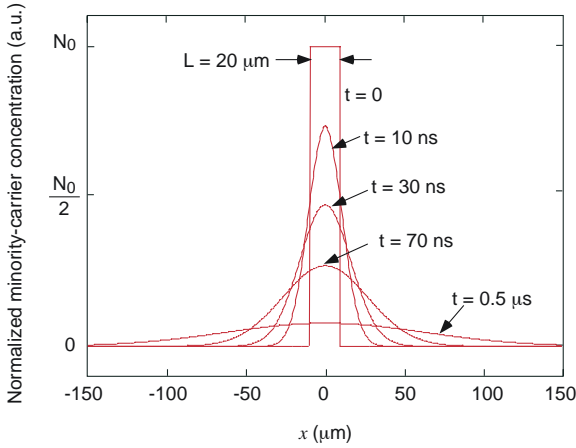
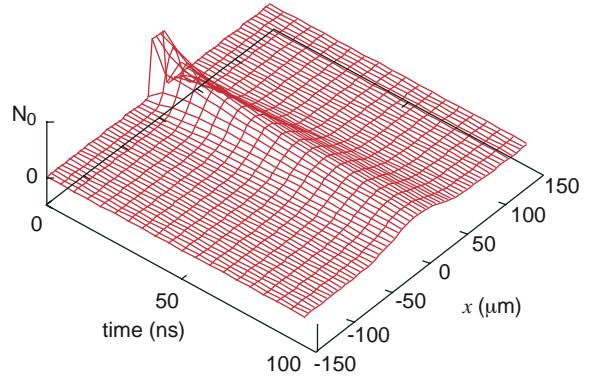

Fig. 7 Minority-carrier diffusion in the single reaction device.



where D is the distance between adjacent reaction devices. With a given α , one can estimate the RD device geometries (L and D). Figure 7 shows example plots of Eq. (4) with practical device parameters [$D_n = 39 \text{ cm}^2/\text{s}$ ($\mu_n = 1500 \text{ cm}^2/\text{V s}$), $\tau = 1 \mu\text{s}$ and $L = 20 \mu\text{m}$].

III. SIMULATION RESULTS

We confirmed the operation of the one-dimensional RD system by numerical simulations. The RD equation was obtained along with the x -axis in Fig. 5. At the position of each reaction device, we used the following RD equations that describe spatiotemporal dynamics of the reaction device:

$$\begin{aligned} \frac{\partial U}{\partial t_1} &= k i(U) - \frac{U}{\tau_1(U, V)}, \\ \frac{\partial V}{\partial t_1} &= \tau D_n \frac{\partial^2 V}{\partial x^2} - V + \frac{U}{\tau_1(U, V)}, \end{aligned}$$

where $k i(U)$, U , V and t_1 are the normalized current [$k = \tau I_0 / (C \text{ VDD})$], the normalized capacitor voltage ($U \equiv n/N_0$), the normalized minority-carrier concentration ($V \equiv n/N_0$) and the normalized time ($t_1 = t/\tau$), respectively. In other positions where no reaction device exists, we used the following equations:

$$\frac{\partial U}{\partial t_1} = 0, \quad \frac{\partial V}{\partial t} = \tau D_n \frac{\partial^2 V}{\partial x^2} - V.$$

We solved these equations numerically using the conventional FDTD method.

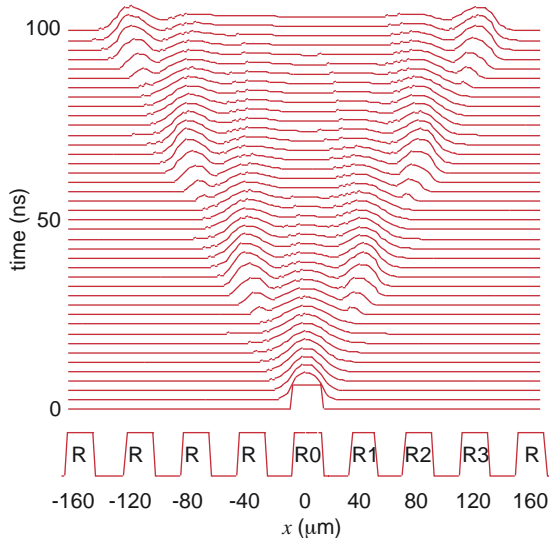

Fig. 8 Reaction-diffusion simulation results of the 1-D RD device

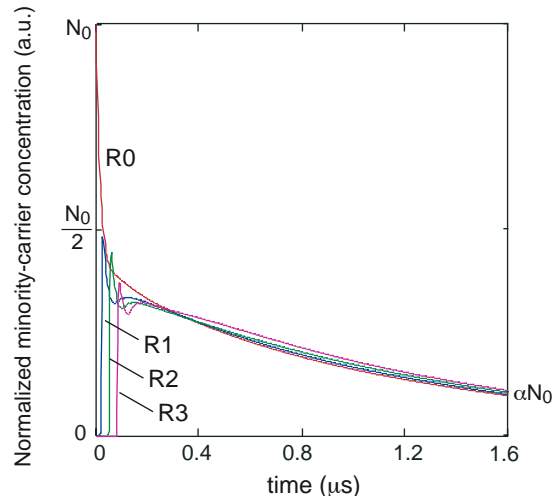

Fig. 9 Time course of the concentration of the center device

Figure 8 shows a result for a RD device with nine reaction devices. In the simulations, we assume $\alpha = 0.1$ and $D = 20 \mu\text{m}$. The rest parameters are set at the same values with the device parameters shown in Fig. 7. In Fig. 8, horizontal and vertical axes represent the space and the time, respectively. The position of the reaction device is indicated by R in the rectangle waves.

At an initial state ($t = 0$), a center reaction device produced minority carriers. The carriers are diffused around the reaction device, and at $t \approx 25 \text{ ns}$, its adjacent devices are turned on (activated). They produce minority carriers as well, then at $t \approx 50 \text{ ns}$ (80 ns), their adjacent reaction devices are activated. The propagating waves are produced in the form of the propagation of the activations of reaction devices.

Very slow decay of the minority carrier concentration was observed in a reaction device being activated by its adjacent device. Figure 9 shows time course of the concentration of the reaction device ($R0$ to $R3$ in Fig. 8). The refractory period was the order of $1 \mu\text{s}$. It was approximately hundred times as long as the propagating time between the adjacent reaction devices. Note that the decay time can be controlled by ejecting minority carriers from the p -sub region.

IV. SUMMARY

We proposed a novel silicon device for imitating autocatalytic and dissipative phenomena of the reaction-diffusion (RD) systems. Numerical simulations showed that the proposed RD device can successfully produce propagating waves in the same way as natural RD systems. Our results indicate that the proposed RD device will be an useful tool for developing novel hardware based on the RD mechanism.

ACKNOWLEDGEMENT

This study was supported by the “Analog Reaction-Diffusion Chip: The Development of Functional LSIs recovering Fingerprint Images” in '00 from the New Energy and Industrial Technology Development Organization (NEDO) of Japan.

REFERENCES

- [1] G. Nicolis and I. Prigogine, *Self-organization in Nonequilibrium Systems — From Dissipative Structures to Order through Fluctuations*. John Wiley & Sons, Inc., 1977.
- [2] R. J. Field and M. Burger, *Oscillations and travelling waves in chemical systems*. John Wiley & Sons, Inc., 1985.