

Natural Computation with Analog Reaction-Diffusion Circuits

Tetsuya ASAI and Yoshihito AMEMIYA
Department of Electronics, Hokkaido University
Kita 13, Nishi 8, Kita-ku, Sapporo, 060-8628 Japan.
asai@sapiens-ei.eng.hokudai.ac.jp

Abstract

We introduce novel analog devices that emulate a model of chemical systems in nature, called a reaction-diffusion (RD) system. The RD system gives us a lot of clues and insights for developing a new paradigm computing. We here exhibit the hardware RD devices and typical operations of them, including the production of travelling and spiral waves in two-dimensional RD devices. The hardware RD device can be used to clarify natural RD systems and be easily integrated into existing digital systems.

1. Introduction

Nonlinear oscillatory phenomena can be observed everywhere in the world. For instance, dissipative and autocatalytic reaction systems, which include almost every natural phenomenon, produce various spatiotemporal patterns through oscillatory reaction and diffusion of chemical species. Such chemical system, where the reaction and diffusion of chemical species coexist under a nonequilibrium condition, is called a reaction-diffusion (RD) system [1]. Typical oscillatory behaviors in RD systems can be observed in the Belousov-Zhabotinsky (BZ) reaction, which is a periodic oxidation-reduction phenomenon among liquid-state reagents. It produces a variety of the rhythms and orders in the form of propagating chemical waves.

The RD system gives us important clues to reveal the relation between chemical reaction and vital phenomena in nature. Recent topic in such field is a control of phase-lagged stable synchronous patterns in two-dimensional (2D) space [2], called modelock or spiral waves. Several ideas for practical applications that utilize properties of RD systems have been proposed, e.g., ideas for chemical image processing, optimal path planning, and binary logic processing. These results suggest that natural systems that make actions primarily for themselves will serve us by both understanding RD systems and reconstructing them in artificial RD media.

Implementing RD systems in hardware has several merits. First, hardware RD system is very useful for simulating RD phenomena, even if the phenomena never occurs in nature. This implies that the hardware systems is one possible candidate for developing an artificial RD system that is superior to natural system. Second, hardware RD system can operate much faster than actual RD systems. This property is useful for developers of RD applications because every RD application benefits from the operation speed. Motivated by these properties, we have developed such hardware RD system, which we call *reaction-diffusion chip*, to imitate various RD phenomena in nature (e.g., orders and rhythms, pattern formation, self organization in biological systems, etc.) on silicon VLSIs [3, 4, 5]. In this paper, we introduce some of them briefly.

2. A Reaction-Diffusion Device using Minority-Carrier Transport

The RD device we have proposed is illustrated in Fig. 1. It consists of four-layer $p-n-p-n$ diodes arranged regularly on a silicon substrate. Each $p-n-p-n$ diode is connected with a capacitor and a current source to form a relaxation oscillator as shown in Fig. 2. This oscillator acts as a unit cell that imitates a chemical reaction, a substrate-depleted reaction, so we call the oscillator a *reaction cell*. During the cycle of oscillation, the reaction cell produces minority carriers (electrons) in the inner p region. The point of our idea is to use the minority carriers as diffusion substances; i.e., electrons produced by a reaction cell will travel through the inner p region by diffusion and reach the neighboring reaction cells to activate the cells (see Fig. 1). A two-dimensional RD system can thus be constructed on a silicon chip.

The state of the reaction cell can be represented by two variables, i.e., charge u stored on the capacitor and charge v of the minority carriers in the $p-n-p-n$ diode. The dynamics of the reaction cell is described by

$$\frac{du}{dt} = i(u) - \frac{u}{\tau(u, v)} \quad (1)$$

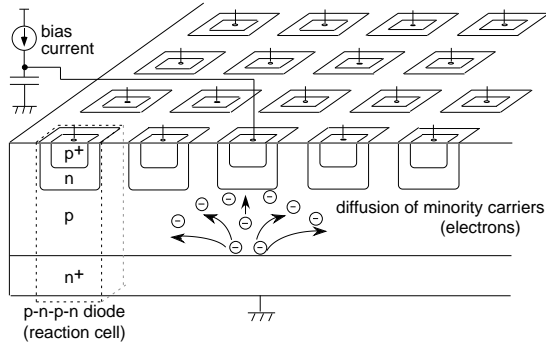

Figure 1. The reaction-diffusion device (RD device) consisting of an array of $p-n-p-n$ diodes.

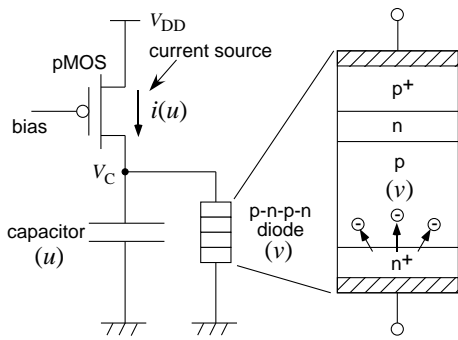

Figure 2. The reaction cell consisting of a $p-n-p-n$ diode, a capacitor, and a current source. The current source consists of a p MOS transistor.

$$\frac{dv}{dt} = -v + \frac{u}{\tau(u, v)} \quad (2)$$

where charges u and v are normalized. The bias current $i(u)$ from the p MOS current source is a function of u and is also normalized. The characteristic of the $p-n-p-n$ diode is represented by nonlinear function $\tau(u, v)$. Minority-carrier charge v increases through a multiplication process caused by the feedback mechanism of the $p-n-p-n$ diode, while capacitor charge u decreases by the amount equal to the increased minority carriers. The operation is categorized into a substrate-depleted reaction.

The reaction cell can be oscillatory (astable) or excitatory (monostable) depending on supply voltage V_{DD} . It is oscillatory if V_{DD} is higher than breakover voltage V_B of the $p-n-p-n$ diode, and excitatory if V_{DD} is lower than V_B . In the oscillatory condition ($V_{DD} > V_B$), the capacitor is charged by bias current $i(u)$ and consequently, capacitor charge u increases until capacitor voltage V_C reaches breakover voltage V_B . When V_C reaches V_B , the breakover

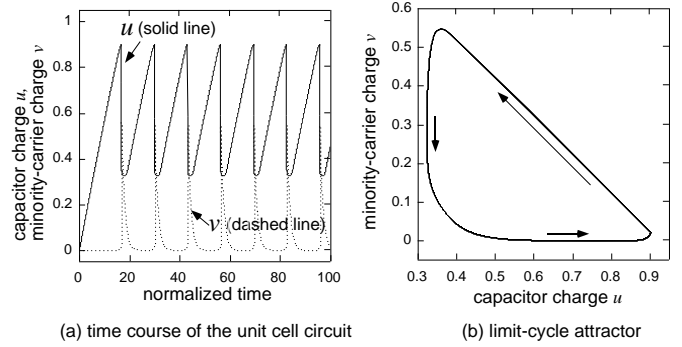

Figure 3. Dynamical properties of the oscillatory reaction cell (simulation). (a) Time evolution; (b) limit-cycle attractor on the $u-v$ plane.

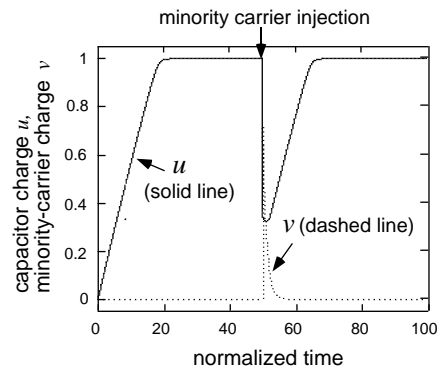

Figure 4. Time evolution in the excitatory reaction cell (simulation).

of the $p-n-p-n$ diode starts and minority carriers are injected from the $n+$ region to the p region. Then, the autocatalytic multiplication of minority carriers occurs to turn the diode on. The stored charge on the capacitor flows into the diode, so capacitor charge u (therefore capacitor voltage V_C) decreases and consequently, the diode is turned off. The reaction cell repeats this cycle and produces oscillatory dynamics. Figures 3(a) and 3(b) illustrate an example of the numerical solutions to Eqs. (1) and (2). Figure 3(a) shows the relaxation oscillations in variables u and v . The limit-cycle attractor is shown in Fig. 3(b).

In the excitatory condition ($V_{DD} < V_B$), capacitor voltage V_C cannot reach breakover voltage V_B because V_C does not exceed supply voltage V_{DD} (bias current $i(u)$ becomes 0 when V_C increases up to V_{DD}). In this condition, the $p-n-p-n$ diode turns on only when minority carriers are injected from neighboring diodes. Figure 4 shows an example of the excitatory behavior of the reaction cell. The cell settles down in the stable state of $u = 1$ and $v = 0$, and no further change occurs as long as minority carriers are not injected.

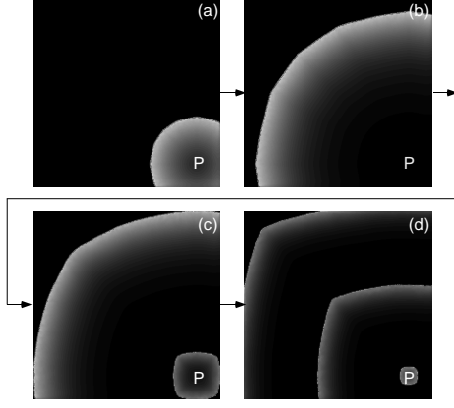

Figure 5. Generation of spreading concentric patterns in a RD device (simulation).

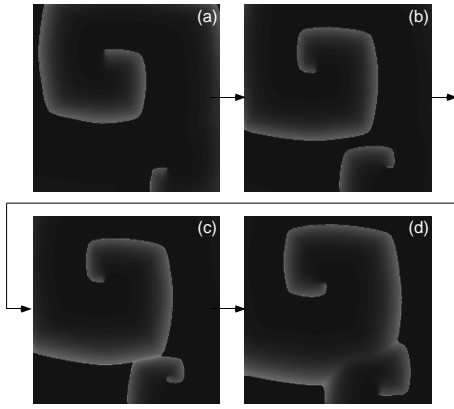

Figure 6. Generation of rotating spiral patterns in a RD device (simulation).

In the simulation, minority carriers were injected from the outside at time = 50. Triggered by this injection, the p - n - p - n diode turned on for once, and then returned to the stable state.

We designed two-dimensional RD device by arranging the reaction cells on a plane and confirmed the device operation by computer simulation. At the position of each reaction cell, we used the following RD equations that describe spatiotemporal dynamics of the cell:

$$\begin{aligned}\frac{\partial u(x, y)}{\partial t} &= i(u) - \frac{u}{\tau(u, v)}, \\ \frac{\partial v(x, y)}{\partial t} &= D_v \nabla^2 v - v + \frac{u}{\tau(u, v)}.\end{aligned}$$

where (x, y) are the rectangular coordinates of any point on the RD-device plane, ∇^2 the Laplacian operator, and D_v the normalized diffusion coefficient. In other positions where

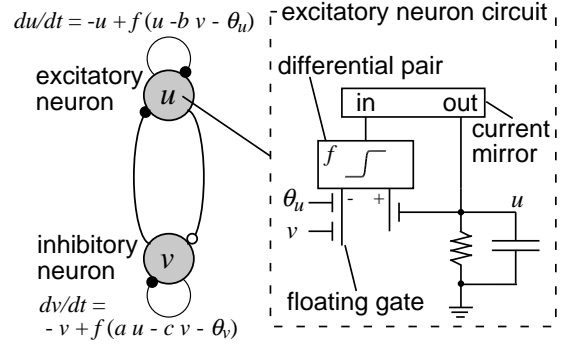

Figure 7. The WC Circuit.

no reaction cell exists, we used the following equations:

$$\frac{\partial u(x, y)}{\partial t} = 0, \quad \frac{\partial v(x, y)}{\partial t} = D_v \nabla^2 v - v.$$

We solved these equations numerically using the conventional FDTD method.

Figure 5 shows a result for a device with 200×200 excitatory reaction cells. The spatial density of minority carriers is represented in grayscale ($v = 0$: black, $v = 1$: white). With periodic injection of minority carriers at a point (P in Fig. 5), the RD device produced spreading concentric waves of minority carriers. This results indicate that the injected carriers diffused around the injection point and successfully induced a chain of reactions of the cells.

Figure 6 shows a result of the excitatory RD device without external injections of minority carriers. With an appropriate initial pattern of minority-carrier densities, the RD device produced rotating spiral patterns of minority carriers. Notice that the wave disappears at collision points [Figs. 6(c) through (d)] because of the depletion of minority carriers. This is the same phenomenon as observed in natural RD systems.

3. A Hardware RD System with Analog CMOS Circuits

We here introduce an analog CMOS circuit that implements a neuromorphic RD model, called the Wilson-Cowan (WC) system. The WC system imitates the group activities of cortical neurons [6]. A large-scale network of locally-coupled WC oscillators can be easily implemented on silicon chips, using the our analog WC circuit. The WC circuits collectively produce various dissipative patterns (e.g., Turing patterns and spiral ones) on the chip. These dissipative patterns are of the same kind as observed in reaction diffusion systems [1]. Since the chip consists of neural oscillators and its construction is similar to typical reaction-

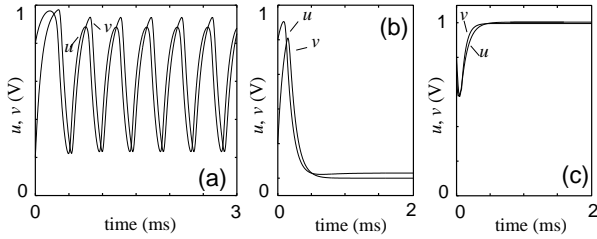

Figure 8. Three types of attractors of the WC circuit.

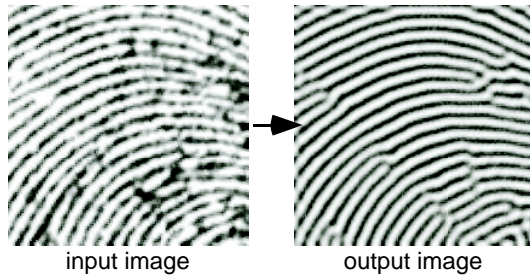

Figure 9. Example operation of the RD neuro chip.

diffusion systems, we call the chip “reaction-diffusion (RD) neuro chips”.

The RD chip consists of i) reaction circuits that emulate elementary interactions between neurons (or chemical substances) and ii) diffusion devices that imitate synapses (or chemical diffusion of the substances). The reaction circuit is arranged on a hexagonal grid and is connected with its neighboring circuits through the diffusion devices.

Figure 7 shows the construction of the reaction circuit (hereafter called the WC circuit) that consists of excitatory- and inhibitory-neuron circuits. Both neuron circuits have the same structure except for the polarity of synaptic connections. The sigmoidal response (f) of the neuron circuit is obtained by a CMOS differential pair consisting of floating-gate transistors. The differential pair also acts as excitatory and inhibitory synapses. It accepts an excitatory input (u) and inhibitory inputs (v) through “+” and “-” terminals, respectively.

The stability of a WC circuit can be controlled by the magnitude of the external inputs (θ_u and θ_v), as predicted in the WC models. Figure 3 shows three types of responses of the WC circuit, i.e., two fixed-points [Fig. 8(a) and 8(b)] and a limit-cycle attractor [Fig. 8(c)].

To construct the RD chip, a number of WC circuits are arranged on a silicon chip and the status nodes (u and v) of each WC circuit is connected with synaptic terminals of the neighboring circuit. The stability of each WC circuit

is thus determined by its neighbors, as in typical dissipative systems. Utilizing the dissipative properties of the RD chip, we have tried to develop image processing systems. Figure 9 shows a simulated result of fingerprint image processing. The RD chip was configured to generate stable stripe patterns (Turing patterns). When a real fingerprint image was given to the chip as initial states (Fig. 9 left), the chip successfully produced a stable fingerprint pattern without noises and unnatural discontinuities of wrinkles (Fig. 9 right). This example implies future potentialities of RD chips in engineering applications.

4 Summary

We introduced silicon devices that imitate autocatalytic and dissipative phenomena of the reaction-diffusion (RD) systems. Numerical simulations showed that the RD device can successfully produce concentric and spiral waves in the same way as natural RD systems. These results encourage us to develop novel applications based on natural RD phenomena using the hardware RD devices.

References

- [1] G. Nicolis and I. Prigogine, *Self-organization in Nonequilibrium Systems — From Dissipative Structures to Order through Fluctuations*. John Wiley & Sons, Inc., 1977.
- [2] R. Kapral and K. Showalter, *Chemical Waves and Patterns*. Kluwer Academic Publishers, 1995.
- [3] T. Asai, Y. Nishimiya, and Y. Amemiya, “A CMOS reaction-diffusion circuit based on cellular-automaton processing emulating the Belousov-Zhabotinsky reaction,” *IEICE Trans. Fundamentals*, Vol. E85-A, No. 9, pp. 2093-2096, 2002.
- [4] T. Asai, Y. Nishimiya, and Y. Amemiya, “A novel reaction-diffusion system based on minority-carrier transport in solid-state CMOS devices,” in *Proc. Int. Semiconductor Device Research Symp.*, 2001, pp. 141-144.
- [5] H. Kato, T. Asai, and Y. Amemiya, “Reaction-diffusion neuro chips: analog CMOS implementation of locally coupled Wilson-Cowan oscillators,” in *Proc. 5th Int. Conf. on Cognitive and Neural Systems*, 2001, P2-41.
- [6] H.R. Wilson and J.D. Cowan, Excitatory and inhibitory interactions in localized populations of model neurons, *Biophys. J.*, Vol. 12, pp. 1-24, 1972.